



Guidelines on the Declaration of Conformity

A conformity evaluation has been carried out for the product in terms of the EU Low Voltage Directive 2014/35/EU and the Electromagnetic Compatibility (EMC) Directive 2014/30/EU. The Declaration of Conformity is laid out in writing in a separate document and can be requested if required.

Guidelines on the EMC Directive (2014/30/EU)

The product cannot be operated independently according to the EMC directive. Only after integration of the product into an overall system can this be evaluated in terms of the EMC. For electronic equipment, the evaluation has been verified for the individual product in laboratory conditions, but not in the overall system.

Guidelines on the Machinery Directive (2006/42/EC)

The product is a component for installation into machines according to the machinery directive 2006/42/EC. The product can fulfil the specifications for safety-related applications in coordination with other elements. The type and scope of the required measures result from the machine risk analysis. The product then becomes a machine component and the machine manufacturer assesses the conformity of the safety device to the directive. It is forbidden to start use of the product until you have ensured that the machine accords with the regulations stated in the directive.

Guidelines on the ATEX Directive

Without a conformity evaluation, this product is not suitable for use in areas where there is a high danger of explosion. For application of this product in areas where there is a high danger of explosion, it must be classified and marked according to directive 2014/34/EU.

Safety and Guideline Signs

DANGER



Immediate and impending danger, which can lead to severe physical injuries or to death.

CAUTION



Danger of injury to personnel and damage to machines.



Guidelines on important points.

General Safety Guidelines

DANGER



Danger of death! Do not touch voltage-carrying lines and components.

Danger



Danger of burns when touching hot surfaces

CAUTION



- Danger from devices caused by short-circuits and earth short-circuits at the terminals
- Electronic devices cannot be guaranteed fail-safe.

During the risk assessment required when designing the machine or system, the dangers involved must be evaluated and removed by taking appropriate protective measures.

To prevent injury or damage, only professionals and specialists are allowed to work on the devices. They must be familiar with the dimensioning, transport, installation, initial operation, maintenance and disposal according to the relevant standards and regulations.

General Safety Guidelines



Only carry out installation, maintenance and repairs in a de-energised, disengaged state and secure the system against inadvertent switch-on.



Before product installation and initial operation, please read the Installation and Operational Instructions carefully and observe the Safety Regulations. Incorrect operation can cause injury or damage.

Application

Rectifiers are used to connect DC consumers to alternating voltage supplies, for example electromagnetic brakes and clutches (ROBA-stop®, ROBA-quick®, ROBATIC®), electromagnets, electrovalves, contactors, switch-on safe DC motors, etc.

Function

The AC input voltage (VAC) is rectified (VDC) in order to operate DC voltage units. Also, voltage peaks, which occur when switching off inductive loads and which may cause damage to insulation and contacts, are limited and the contact load reduced.

Electrical Connection (Terminals)

- 1 + 2 Input voltage
- 3 + 4 Connection for an external switch for DC-side switching
- 5 + 6 Coil
- 7 – 10 Free nc terminals (only for Size 2)
When connecting to PELV, only for overvoltage category II

Intended Use

mayr®-rectifiers have been developed, manufactured and tested as electronic equipment in compliance with the DIN EN 50178 standard and in accordance with the EU Low Voltage Directive. During installation, operation and maintenance of the product, the requirements for the standard must be observed. mayr®-rectifiers are for use in machines, systems and devices and must only be used in the situations for which they are ordered and confirmed. The products are designed for installation into electrical control cabinets and terminal boxes. Using them for any other purpose is not allowed.

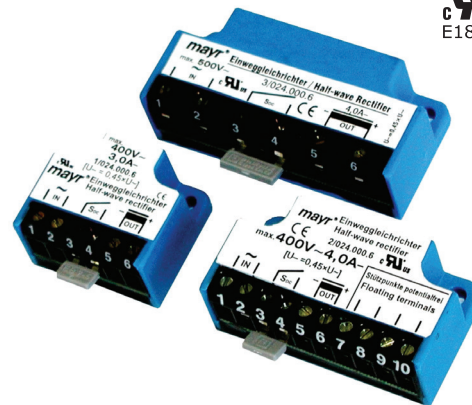



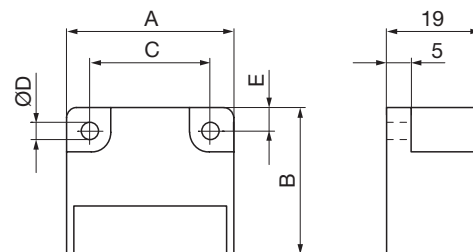









Dimensions (mm)



Sizes	A	B	C	ØD	E
1	34	30	25	3.5	4.5
2	54	30	44	4.5	5.0
3/4	64	30	54	4.5	5.0

Accessories: Mounting bracket set for 35 mm rail acc. EN 60715: Article No. 1803201

Technical Data				Bridge rectifier		Half-wave rectifier				
Calculation output voltage				$U_{\text{bridge}} = 0.9 \times U_{\text{AC}}$		$U_{\text{half-wave}} = 0.45 \times U_{\text{AC}}$				
Type				1/025	2/025	1/024	2/024	3/024	4/024	
Max. input voltage		± 10%	U_{AC} [VAC]	230	230	400	400	500	600	
Max. output voltage			U_{DC} [VDC]	207	207	180	180	225	270	
Output current		at ≤ 50 °C	I_{RMS} [A]	2.5	2.5	3.0	4.0	4.0	4.0	
		at max. 85 °C	I_{RMS} [A]	1.7	1.7	1.8	2.4	2.4	2.4	
Max. coil nominal capacity at		$U_{\text{AC}} = 115 \text{ VAC}$	≤ 50 °C	P_{N} [W]	260	260	-	-	-	-
			up to 85 °C	P_{N} [W]	177	177	-	-	-	-
		$U_{\text{AC}} = 230 \text{ VAC}$	≤ 50 °C	P_{N} [W]	517	517	312	416	416	416
			up to 85 °C	P_{N} [W]	352	352	187	250	250	250
		$U_{\text{AC}} = 400 \text{ VAC}$	≤ 50 °C	P_{N} [W]	-	-	540	720	720	720
			up to 85 °C	P_{N} [W]	-	-	324	432	432	432
		$U_{\text{AC}} = 500 \text{ VAC}$	≤ 50 °C	P_{N} [W]	-	-	-	-	900	900
			up to 85 °C	P_{N} [W]	-	-	-	-	540	540
$U_{\text{AC}} = 600 \text{ VAC}$	≤ 50 °C	P_{N} [W]	-	-	-	-	-	1080		
	up to 85 °C	P_{N} [W]	-	-	-	-	-	648		
Peak reverse voltage			[V]	1600	1600	2000	1600	2000	2000	
Rated insulation voltage			U_{RMS} [V _{RMS}]	320	320	500	500	630	630	
Pollution degree (insulation coordination)				1	1	1	1	1	1	
Device fuses				To be included in the input voltage line.						
Recommended microfuse switching capacity H The microfuse corresponds to the max. possible connection capacity. If fuses are used corresponding to the actual capacities, the permitted limit integral I^2t must be observed on selection.				FF 3.15 A	FF 3.15 A	FF 4 A	FF 5 A	FF 5 A	FF 5 A	
Permitted limit integral			I^2t [A ² s]	40	40	50	100	50	50	
Protection				IP65 components, encapsulated / IP20 terminals						
Terminals				Cross-section 0.14 – 1.5 mm ² (AWG 26-14)						
Ambient temperature			[°C]	-25 to +85						
Storage temperature			[°C]	-40 to +85						
Conformity markings										
										
Installation conditions				The installation position can be user-defined. Please ensure sufficient heat dissipation and air convection! Do not install near to sources of intense heat!						

Wiring Example

(400 VAC, AC-side switching)

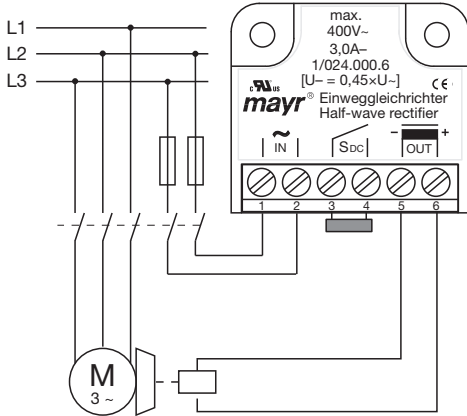

AC-side switching means **low-noise switching**; however, the brake engagement time is longer (approx. 6 – 10 times longer than with DC-side switch-off), use for non-critical braking times.

Wiring Example

(400 VAC, DC-side switching)

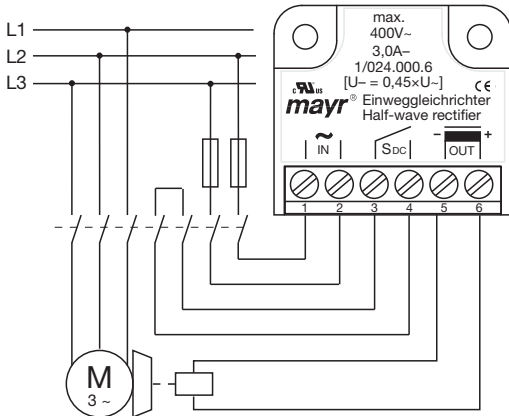

DC-side switching means **short brake engagement times (e.g. for EMERGENCY STOP operation)**; however, louder switching noises.

Protection circuit



When using DC-side switching, the coil must be protected by a suitable protection circuit according to VDE 0580, which is integrated in *mayr*[®]-rectifiers. Nevertheless, the high voltage induced on circuit interruption produces switching sparks, which lead to contact consumption.

Therefore, only use the main contacts of a contactor suitable for inductive loads with a minimum contact opening of 3 mm for switching the DC-side contact S_{DC}. Connecting the main contacts in series reduces wear.

EMC-compatible Installation

This rectifier does not produce any interference. However, if the device is used in connection with other components (e.g. electromagnetic brakes), the resulting interference can exceed the permitted limit values. Please therefore install the rectifier in accordance with the EMC directives!

The measure described for compliance with the EMC directive is examined under laboratory conditions, and cannot necessarily be bindingly transferred onto the condition of a machine or equipment in case of deviations. The inspection tests the individual components *mayr*[®]-rectifier and the *mayr*[®]-brake and is applicable for an input voltage of up to 600 VAC.

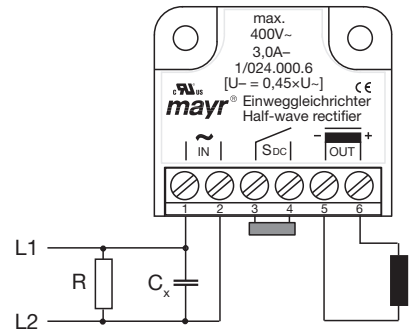

Measure

Installation of a C_x-capacitor into the AC connection:

- C_x = 330 nF / 250 V up to 230 V input voltage
- C_x = 330 nF / 440 V up to 400 V input voltage
- C_x = 330 nF / 660 V up to 600 V input voltage
- R = 0.5 MΩ discharge resistor

Please mount the C_x-capacitor directly onto the rectifier (connection terminal)!



- Avoid an antennae effect: Keep the supply cables as short as possible; do not form rings or loops with the cables!
- Mount good earth connections onto the metal body of the brake!
- Lay control cables separately from power cables or from strongly pulsating supply cables!

Standards

Product standard

VDE 0160/DIN EN 50178:1998-04

Electronic equipment for use in power installations

EMC inspections

EN 61000-6-2:2006-03

Interference immunity

EN 61000-6-4:2007-09

Interference emission

Insulation coordination

acc. VDE 0110 / EN 60664:2008-01

Overvoltage category III